

LOW VOLTAGE AC DRIVES

# ABB general purpose drives

ACS310, 0.37 to 22 kW/0.5 to 30 hp



---

**Make wise savings with your pump and fan applications. ACS310 drives.**

---

# Table of contents

<b>04–05</b>	<b>ACS310 drives for a wide range of variable torque applications</b>
<b>06–07</b>	<b>Essentials inside for basic applications</b>
<b>08</b>	<b>Typical applications</b>
<b>09</b>	<b>How to select a drive</b>
<b>10</b>	<b>Ratings and types</b>
<b>11</b>	<b>Technical data</b>
<b>12–13</b>	<b>Dimensions and weights</b>
<b>14</b>	<b>Cooling and fuses</b>
<b>15</b>	<b>Control connections</b>
<b>16–17</b>	<b>Control program example</b>
<b>18–24</b>	<b>Options</b>
<b>25</b>	<b>Compact AC500-eCo PLC with ACS310</b>
<b>26–27</b>	<b>ABB product offering</b>
<b>28–30</b>	<b>Drives service</b>

# ACS310 drives for a wide range of variable torque applications

ABB general purpose drive, ACS310 is easy to select and easy to use. It is enough for most basic applications with no high overload demands. ACS310 is suitable for wide range of variable torque applications and simple machines.

The drive's dedicated pump and fan features lower operating costs, boost energy efficiency and reduces CO<sub>2</sub> emissions. Included amongs these features are built-in PID controllers and PFC (pump and fan control) that varies the drive's performance in response to changes in pressure, flow or other external data.

Among the pre-programmed protection functions is pump cleaning. This prevents pump and pipe clogging by initiating a sequence of forward and reverse runs of the pump to clean the impeller.

Within pumping applications, energy savings can be up to 50 percent, compared to direct-on-line motor-driven systems that use mechanical flow control methods. The ABB general purpose drives provide built-in features for efficient energy management. Energy savings can be easily monitored using the built-in counters that display energy savings in kilowatt hours and saved carbon dioxide emissions. The savings can also be displayed in local currencies.

The compact design and uniform dimensions make cabinet mounting of the drive straightforward, thereby providing a fast and space saving installation. The ACS310 drives have an embedded Modbus interface for system monitoring that saves the cost of external fieldbus devices and enables to integrate the drives easily with PLC. When combined with preprogrammed application macros, an intuitive user interface and several assistant screens, installation time is further reduced while speeding up parameter setting and drive commissioning.

The ACS310 drives meet the needs of OEMs, logistical and technical distributors as well as the requirements of end users with pumping and ventilation applications. The drives are supported by one of the most extensive global sales and service networks with presence in over 100 countries.

## Highlights

- Powerful set of pump and fan features
- Boosted energy efficiency
- Tailored for cabinet installations
- Clever drive commissioning assistants and convenient user interface
- Motor noise smoothing
- Worldwide availability and service



# Essentials inside for basic applications

ACS310 drives are simple and easy with all essentials included for applications with no high overload demand.

**Compact design with flexible mounting options saves space and installation time. Short menus and preprogrammed macros makes commissioning fast and easy. The drives powerful set of pump and fan features reduce mechanical stress and thus maintenance costs. Within pumping applications, energy savings of up to 50% can be achieved compared to direct-on-line motor-driven systems that use mechanical flow control methods. Wherever your machine is located, the local ABB will be there to support you and your clients.**

## Multipump and -fan control

One drive controls several pumps or fans and eliminates the need for an external programmable logic controller. One pump is drive controlled and auxiliary pumps are on/off controlled. This reduces the motor stress and increase lifetime when auxiliary motors are driven according to the needed pump/fan capacity. Interlock function enables one motor to be disengaged from the mains supply while others continue operating in parallel.

## Quick and easy commissioning

Predefined I/O configurations for application macros and built-in assistants speed up commissioning of the drive, allowing you to concentrate on your business.

## Robust design and quality

ACS310 has coated control boards to increase robustness. Automatic fault reset to ensure uninterrupted operation. And protection against unstable supply networks.

## Energy optimizer

Intelligent drive control method improving the energy efficiency and system operation, especially while operating on partial centrifugal loads.

## Load analyzer

Built-in statistical tool that saves process data, such as current and torque values, which can be used to analyze and optimise the process. It can also be used for following system behaviour before and after any system modifications.



### Compact and space saving design

Compact size, with power range from 0.37 to 22 kW and flexible mounting possibilities ensure optimized installation in a wide range of applications, resulting in space and cost savings.

### Powerful set of pump and fan features

Integrated and preprogrammed features like pump cleaning, pipefill, inlet/outlet pressure supervision and detection of under or overload improve system reliability and lifetime. Built-in PFC feature can eliminate the need for an external programmable logic controller (PLC).

### Internal Modbus EIA-485 connection

Built-in terminals and connectivity for Modbus RTU as standard enables the system control and monitoring in the most user friendly and cost effective way.

### Relay extension module MREL-01

The optional MREL-01 module offers three additional relay outputs. The outputs can be configured for different functions by setting selected parameters eg, for multipump/-fan control.

### Remote monitoring

Optional SREA-01 module enables remote monitoring and access to drive's parameters and process via webbrowser. It enables sending log files, alarms and events by E-mail and SMS. Additionally SREA-01 offers Modbus TCP connectivity to ACS310.

### FlashDrop tool

FlashDrop is a powerful palm sized drive configuration tool that copies a pre-defined drive parameter set into a drive in 2 seconds without a power connection to the drive.



# Typical applications

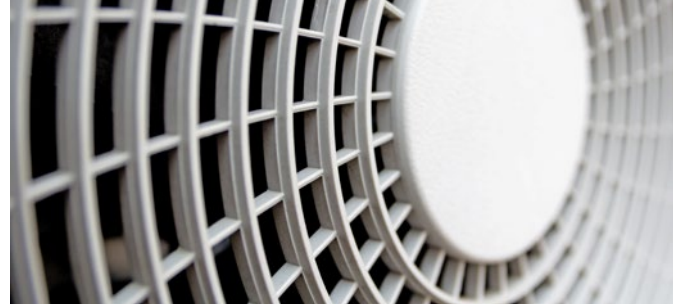

The ACS310 drive is specifically designed to meet the variable torque loads demanded by centrifugal fans and pumps. The result is maximum application uptime, reduced maintenance cost and higher energy savings.

**Irrigation systems**, whether agricultural, horticultural or those used on golf courses, have a common demand for a reliable and efficient flow of water.

The built-in real-time clock provides true time and date stamps that control the start and stop times of watering based on the daily demand profile. Soft pipe filling provides a pump with soft-start, enabling a smooth build-up of flow in pipes while increasing the life time of the pipe work and pumping system.

**A booster pump system** is designed to boost supplied water pressure to a predetermined level in water and wastewater plants. The ACS310 drive features pump and fan control (PFC) for use where several parallel pumps are operated together and the required flow rate is variable.

PID control is available to allow the process to accurately maintain a pressure setpoint by adjusting the control outputs, thus allowing for precise control within difficult processes. A sleep & boost function detects slow rotation and runs the pump to boost pressure prior to

shutdown. The pressure is continuously monitored and pumping restarts when the pressure falls below the minimum level.

**Level control** is used to adjust the filling or emptying of storage tanks. Storage tanks may be located within processes such as pulp and paper for supplying process fluids like wastewater. The drive has signal supervision for level control and a pipe cleaning feature, thereby preventing solids from building up on pumps impellers or the tank walls.

Storage tanks are often mounted in narrow locations, with limited space for components like AC drives. The compact size and various mounting methods of the ACS310 drives enables easy installation and space savings in new installations and retrofits.

**Wood drying kilns** have a high demand for powerful and efficient ventilation to dry out the wood. In wood kilns centrifugal fans and AC drives are used to control the air flow demand. To increase the kilns' capacity, multiple fans may be controlled via one drive by using the pump and fan control (PFC) feature. At the start of the drying process, the relative humidity is high thus there is a demand for higher air flow rates. As the wood dries out the auxiliary fans may shut-down, thereby saving energy and reducing maintenance.



# How to select a drive

It is very easy to select the right drive. This is how you build up your own ordering code using the type designation key.

Start with identifying your supply voltage. This tells you what rating table to use. See page 10.



Choose your motor's power and current rating from the ratings table on page 10.

Select your drive's ordering code from the rating table based on your motor's nominal power rating.

10 ABB GENERAL PURPOSE DRIVES, ACS310, CATALOG

### Ratings and types

Rating	$I_n$ (A)	$I_{rms}$ (A)	$I_{sc}$ (A)	Type designation	Frame size	Type designation
<b>1-phase AC supply, 200 to 240 V</b>						
0.37	0.65	2.4	2.3	ACS310-01R-02A-2	R0	
0.75	1.0	4.7	4.5	ACS310-01R-04A-2	R1	
1.5	1.5	6.7	6.5	ACS310-01R-06A-2	R1	
1.5	2.0	7.5	7.2	ACS310-01R-07A-2	R1	
3.0	3.0	9.0	8.4	ACS310-01R-08A-2	R2	
<b>1-phase AC supply, 230 to 480 V</b>						
0.37	0.5	2.4	2.4	ACS310-01R-02A-2	R0	
0.75	0.75	3.5	3.5	ACS310-01R-03A-2	R0	
0.75	1.0	5.2	4.7	ACS310-01R-04A-2	R1	
1.5	1.5	7.4	6.7	ACS310-01R-05A-2	R1	
1.5	2.0	8.3	7.5	ACS310-01R-06A-2	R1	
3.0	3.0	10.8	9.8	ACS310-01R-07A-2	R2	
3.0	4.0	14.4	13.2	ACS310-01R-08A-2	R2	
4.0	6.0	18.0	17.6	ACS310-01R-09A-2	R2	
5.5	7.5	20.4	24.4	ACS310-01R-10A-2	R2	
7.5	10.0	24.0	30.0	ACS310-01R-11A-2	R2	
11.0	15.0	30.0	40.0	ACS310-01R-12A-2	R4	
<b>2-phase AC supply, 200 to 240 V</b>						
0.37	0.65	2.4	2.3	ACS310-02R-02A-4	R0	
0.75	1.0	4.7	4.5	ACS310-02R-03A-4	R1	
1.5	1.5	6.7	6.5	ACS310-02R-04A-4	R1	
1.5	2.0	7.5	7.2	ACS310-02R-05A-4	R1	
3.0	3.0	9.0	8.4	ACS310-02R-06A-4	R1	
3.0	4.0	12.0	11.2	ACS310-02R-07A-4	R1	
4.0	6.0	16.0	15.2	ACS310-02R-08A-4	R2	
5.5	7.5	20.4	24.4	ACS310-02R-09A-4	R2	
7.5	10.0	24.0	30.0	ACS310-02R-10A-4	R2	
11.0	15.0	30.0	40.0	ACS310-02R-11A-4	R4	
<b>2-phase AC supply, 230 to 480 V</b>						
0.37	0.5	2.4	2.4	ACS310-02R-02A-4	R0	
0.75	0.75	3.5	3.5	ACS310-02R-03A-4	R0	
0.75	1.0	5.2	4.7	ACS310-02R-04A-4	R1	
1.5	1.5	7.4	6.7	ACS310-02R-05A-4	R1	
1.5	2.0	8.3	7.5	ACS310-02R-06A-4	R1	
3.0	3.0	10.8	9.8	ACS310-02R-07A-4	R2	
3.0	4.0	14.4	13.2	ACS310-02R-08A-4	R2	
4.0	6.0	18.0	17.6	ACS310-02R-09A-4	R2	
5.5	7.5	20.4	24.4	ACS310-02R-10A-4	R2	
7.5	10.0	24.0	30.0	ACS310-02R-11A-4	R2	
11.0	15.0	30.0	40.0	ACS310-02R-12A-4	R4	

**Notes:**  
 \* This is the unique reference number (shown in column 5, right) that clearly identifies your drive by current rating and frame size. Once the drive's type designation has been selected, the frame size (column 6) can be used to determine the drive dimensions, shown on page 12.  
**Voltages**  
 ACS310 is available in two voltage ranges:  
 2 = 200 to 240 V  
 4 = 380 to 480 V  
 Insert either "2" or "4", depending on your chosen voltage, into the type designation shown above.  
**Construction**  
 "R0" within the type designation (shown above) varies depending on the drive phase and EMC filtering. Choose below the one you need:  
 O0 = 1-phase  
 O1 = 3-phase  
 E = EMC filter connected, 50 Hz frequency  
 U = EMC filter disconnected, 60 Hz frequency  
 (In case the filter is required it can easily be connected)

Page 10

Choose your options (on pages 18 to 24) and add the option codes to drive's ordering code. Remember to use a "+" mark before each option code.



10 ABB GENERAL PURPOSE DRIVES, ACS310, CATALOG

### Ratings and types

Rating	$I_n$ (A)	$I_{rms}$ (A)	$I_{sc}$ (A)	Type designation	Frame size	Type designation
<b>1-phase AC supply, 200 to 240 V</b>						
0.37	0.65	2.4	2.3	ACS310-01R-02A-2	R0	
0.75	1.0	4.7	4.5	ACS310-01R-04A-2	R1	
1.5	1.5	6.7	6.5	ACS310-01R-06A-2	R1	
1.5	2.0	7.5	7.2	ACS310-01R-07A-2	R1	
3.0	3.0	9.0	8.4	ACS310-01R-08A-2	R2	
<b>1-phase AC supply, 230 to 480 V</b>						
0.37	0.5	2.4	2.4	ACS310-01R-02A-2	R0	
0.75	0.75	3.5	3.5	ACS310-01R-03A-2	R0	
0.75	1.0	5.2	4.7	ACS310-01R-04A-2	R1	
1.5	1.5	7.4	6.7	ACS310-01R-05A-2	R1	
1.5	2.0	8.3	7.5	ACS310-01R-06A-2	R1	
3.0	3.0	10.8	9.8	ACS310-01R-07A-2	R2	
3.0	4.0	14.4	13.2	ACS310-01R-08A-2	R2	
4.0	6.0	18.0	17.6	ACS310-01R-09A-2	R2	
5.5	7.5	20.4	24.4	ACS310-01R-10A-2	R2	
7.5	10.0	24.0	30.0	ACS310-01R-11A-2	R2	
11.0	15.0	30.0	40.0	ACS310-01R-12A-2	R4	
<b>2-phase AC supply, 200 to 240 V</b>						
0.37	0.65	2.4	2.3	ACS310-02R-02A-4	R0	
0.75	1.0	4.7	4.5	ACS310-02R-03A-4	R1	
1.5	1.5	6.7	6.5	ACS310-02R-04A-4	R1	
1.5	2.0	7.5	7.2	ACS310-02R-05A-4	R1	
3.0	3.0	9.0	8.4	ACS310-02R-06A-4	R1	
3.0	4.0	12.0	11.2	ACS310-02R-07A-4	R1	
4.0	6.0	16.0	15.2	ACS310-02R-08A-4	R2	
5.5	7.5	20.4	24.4	ACS310-02R-09A-4	R2	
7.5	10.0	24.0	30.0	ACS310-02R-10A-4	R2	
11.0	15.0	30.0	40.0	ACS310-02R-11A-4	R4	
<b>2-phase AC supply, 230 to 480 V</b>						
0.37	0.5	2.4	2.4	ACS310-02R-02A-4	R0	
0.75	0.75	3.5	3.5	ACS310-02R-03A-4	R0	
0.75	1.0	5.2	4.7	ACS310-02R-04A-4	R1	
1.5	1.5	7.4	6.7	ACS310-02R-05A-4	R1	
1.5	2.0	8.3	7.5	ACS310-02R-06A-4	R1	
3.0	3.0	10.8	9.8	ACS310-02R-07A-4	R2	
3.0	4.0	14.4	13.2	ACS310-02R-08A-4	R2	
4.0	6.0	18.0	17.6	ACS310-02R-09A-4	R2	
5.5	7.5	20.4	24.4	ACS310-02R-10A-4	R2	
7.5	10.0	24.0	30.0	ACS310-02R-11A-4	R2	
11.0	15.0	30.0	40.0	ACS310-02R-12A-4	R4	

**Notes:**  
 \* This is the unique reference number (shown in column 5, right) that clearly identifies your drive by current rating and frame size. Once the drive's type designation has been selected, the frame size (column 6) can be used to determine the drive dimensions, shown on page 12.  
**Voltages**  
 ACS310 is available in two voltage ranges:  
 2 = 200 to 240 V  
 4 = 380 to 480 V  
 Insert either "2" or "4", depending on your chosen voltage, into the type designation shown above.  
**Construction**  
 "R0" within the type designation (shown above) varies depending on the drive phase and EMC filtering. Choose below the one you need:  
 O0 = 1-phase  
 O1 = 3-phase  
 E = EMC filter connected, 50 Hz frequency  
 U = EMC filter disconnected, 60 Hz frequency  
 (In case the filter is required it can easily be connected)

Page 10

Type designation:

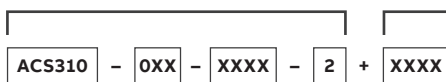

- Product series
- Constructions
- Rating and types
- Voltage
- Options

18 ABB GENERAL PURPOSE DRIVES, ACS310, CATALOG

### Options

**How to select options**  
 The options shown in the table below are available within the ACS310 range. The control panels have an associated 4-figure option code, which is shown in the second column. It is the code that replaces XXXX in the type code above.

Options	Ordering code	Description	Order
Protection class	0500000000	NEMA 1 Type 1 (R0, R1, R2)	M001-B1
	0500000001	NEMA 1, 2, 3 Type 1 (R0, R1, R2)	M001-B2
	0500000002	IP20 (Type 1, 2, 3) (R0, R1, R2)	M001-B3
Control panel	1000	Standard control panel	ACS-CP
	1001	Basic control panel	ACS-CP-B
Power transformer	0000000000	None	ACS-PT-0
	0000000001	Power transformer 100 VA	ACS-PT-1
Extension modules	0000000000	None	ACS-EM-0
	0000000001	Basic input extension module	M001-01
	0000000002	Optical isolation frame (F)	M001-02
	0000000003	Additional analog outputs	M001-03
	0000000004	Frameless top	M001-04
Terminal	0000000000	Standard terminal	M001-00
	0000000001	Drive module light	M001-01
External options	-	EMC filters	ACS-EMC-F
	-	Optical chassis	ACS-EMC-O
	-	Drive module adapter	ACS-EMC-A

**Notes:**  
 \* The ACS310 is compatible with ACS-CP-C Basic control panel Rev. 4 or later.  
 \*\* The ACS310 is compatible with ACS-CP-B Basic control panel Rev. 4 or later.  
 \*\*\* The ACS310 is compatible with ACS-CP-A Basic control panel Rev. 4 or later.  
 \*\*\*\* The ACS310 is compatible with ACS-CP-D Basic control panel Rev. 4 or later.  
 \*\*\*\*\* The ACS310 is compatible with ACS-CP-E Basic control panel Rev. 4 or later.  
 \*\*\*\*\* The ACS310 is compatible with ACS-CP-F Basic control panel Rev. 4 or later.  
 \*\*\*\*\* The ACS310 is compatible with ACS-CP-G Basic control panel Rev. 4 or later.  
 \*\*\*\*\* The ACS310 is compatible with ACS-CP-H Basic control panel Rev. 4 or later.  
 \*\*\*\*\* The ACS310 is compatible with ACS-CP-I Basic control panel Rev. 4 or later.  
 \*\*\*\*\* The ACS310 is compatible with ACS-CP-J Basic control panel Rev. 4 or later.  
 \*\*\*\*\* The ACS310 is compatible with ACS-CP-K Basic control panel Rev. 4 or later.  
 \*\*\*\*\* The ACS310 is compatible with ACS-CP-L Basic control panel Rev. 4 or later.  
 \*\*\*\*\* The ACS310 is compatible with ACS-CP-M Basic control panel Rev. 4 or later.  
 \*\*\*\*\* The ACS310 is compatible with ACS-CP-N Basic control panel Rev. 4 or later.  
 \*\*\*\*\* The ACS310 is compatible with ACS-CP-O Basic control panel Rev. 4 or later.  
 \*\*\*\*\* The ACS310 is compatible with ACS-CP-P Basic control panel Rev. 4 or later.  
 \*\*\*\*\* The ACS310 is compatible with ACS-CP-Q Basic control panel Rev. 4 or later.  
 \*\*\*\*\* The ACS310 is compatible with ACS-CP-R Basic control panel Rev. 4 or later.  
 \*\*\*\*\* The ACS310 is compatible with ACS-CP-S Basic control panel Rev. 4 or later.  
 \*\*\*\*\* The ACS310 is compatible with ACS-CP-T Basic control panel Rev. 4 or later.  
 \*\*\*\*\* The ACS310 is compatible with ACS-CP-U Basic control panel Rev. 4 or later.  
 \*\*\*\*\* The ACS310 is compatible with ACS-CP-V Basic control panel Rev. 4 or later.  
 \*\*\*\*\* The ACS310 is compatible with ACS-CP-W Basic control panel Rev. 4 or later.  
 \*\*\*\*\* The ACS310 is compatible with ACS-CP-X Basic control panel Rev. 4 or later.  
 \*\*\*\*\* The ACS310 is compatible with ACS-CP-Y Basic control panel Rev. 4 or later.  
 \*\*\*\*\* The ACS310 is compatible with ACS-CP-Z Basic control panel Rev. 4 or later.

Page 18

# Ratings and types

Ratings				Type designation	Frame size
$P_N$ (kW)	$P_N$ (hp)	$I_{2N}^{1)}$ (A)	$I_{LD}^{2)}$ (A)		
<b>1-phase AC supply, 200 to 240 V</b>					
0.37	0.5	2.4	2.3	ACS310-01X-02A4-2	R0
0.75	1.0	4.7	4.5	ACS310-01X-04A7-2	R1
1.1	1.5	6.7	6.5	ACS310-01X-06A7-2	R1
1.5	2.0	7.5	7.2	ACS310-01x-07A5-2	R2
2.2	3.0	9.8	9.4	ACS310-01x-09A8-2	R2
<b>3-phase AC supply, 200 to 240 V</b>					
0.37	0.5	2.6	2.4	ACS310-03X-02A6-2	R0
0.55	0.75	3.9	3.5	ACS310-03X-03A9-2	R0
0.75	1.0	5.2	4.7	ACS310-03X-05A2-2	R1
1.1	1.5	7.4	6.7	ACS310-03X-07A4-2	R1
1.5	2.0	8.3	7.5	ACS310-03X-08A3-2	R1
2.2	3.0	10.8	9.8	ACS310-03X-10A8-2	R2
3.0	4.0	14.6	13.3	ACS310-03X-14A6-2	R2
4.0	5.0	19.4	17.6	ACS310-03X-19A4-2	R2
5.5	7.5	26.8	24.4	ACS310-03X-26A8-2	R3
7.5	10.0	34.1	31.0	ACS310-03X-34A1-2	R4
11.0	15.0	50.8	46.2	ACS310-03X-50A8-2	R4
<b>3-phase AC supply, 380 to 480 V</b>					
0.37	0.5	1.3	1.2	ACS310-03X-01A3-4	R0
0.55	0.75	2.1	1.9	ACS310-03X-02A1-4	R0
0.75	1.0	2.6	2.4	ACS310-03X-02A6-4	R1
1.1	1.5	3.6	3.3	ACS310-03X-03A6-4	R1
1.5	2.0	4.5	4.1	ACS310-03X-04A5-4	R1
2.2	3.0	6.2	5.6	ACS310-03X-06A2-4	R1
3.0	4.0	8.0	7.3	ACS310-03X-08A0-4	R1
4.0	5.0	9.7	8.8	ACS310-03X-09A7-4	R1
5.5	7.5	13.8	12.5	ACS310-03X-13A8-4	R3
7.5	10.0	17.2	15.6	ACS310-03X-17A2-4	R3
11.0	15.0	25.4	23.1	ACS310-03X-25A4-4	R3
15.0	20.0	34.1	31	ACS310-03X-34A1-4	R4
18.5	25.0	41.8	38	ACS310-03X-41A8-4	R4
22.0	30.0	48.4	44	ACS310-03X-48A4-4	R4

X within the type designation stands for E or U.

<sup>1)</sup>  $I_{2N}$  maximum continuous output current at ambient temperature of +40 °C.  
No overloadability, derating 1% for every additional 1 °C up to +50 °C.

<sup>2)</sup>  $I_{LD}$  continuous output current at max ambient temperature of +50 °C.  
10% overloadability for one minute every ten minutes.

## Type designation

This is the unique reference number (shown in column 5, right) that clearly identifies your drive by current rating and frame size. Once the drive's type designation has been selected, the frame size (column 6) can be used to determine the drive dimensions, shown on page 12.

## Voltages

ACS310 is available in two voltage ranges:

**2** = 200 to 240 V

**4** = 380 to 480 V

Insert either "2" or "4", depending on your chosen voltage, into the type designation shown above.

## Construction

"XXE" within the type designation (shown above) varies depending on the drive phase and EMC filtering. Choose below the one you need.

**01** = 1-phase

**03** = 3-phase

**E** = EMC filter connected, 50 Hz frequency

**U** = EMC filter disconnected, 60 Hz frequency  
(In case the filter is required it can easily be connected)

# Technical data

<b>Mains connection</b>	
<b>Voltage and power range</b>	1-phase, 200 to 240 V $\pm$ 10% 0.37 to 2.2 kW (0.5 to 3 hp) 3-phase, 200 to 240 V $\pm$ 10% 0.37 to 11 kW (0.5 to 15 hp) 3-phase, 380 to 480 V $\pm$ 10% 0.37 to 22 kW (0.5 to 30 hp)
<b>Frequency</b>	48 to 63 Hz
<b>Motor connection</b>	
<b>Voltage</b>	3-phase, from 0 to $U_{supply}$
<b>Frequency</b>	0 to 500 Hz
<b>Continuous loading capability</b>	$I_{2N}$ maximum continuous output current at ambient temperature of +40 °C. No overloadability, derating 1% for every additional 1 °C up to 50 °C.  $I_{LD}$ continuous output current at max. ambient temperature of +50 °C. 10% overloadability for one minute every ten minutes. At start 1.6 x $I_{2N}$ for 2 s
<b>Switching frequency</b>	
Default	4 kHz
Selectable	4 to 16 kHz with 4 kHz steps
<b>Acceleration time</b>	0.1 to 1800 s
<b>Deceleration time</b>	0.1 to 1800 s
<b>Motor control method</b>	Scalar U/f
<b>Environmental limits</b>	
<b>Ambient temperature</b>	-10 to +40 °C (14 to 104 °F) without derating, +40 to 50 °C (104 to 122 °F) with derating, no frost allowed
<b>Altitude</b>	Rated current available at 0 to 1000 m (0 to 3281 ft) reduced by 1% per 100 m (328 ft) over 1000 to 2000 m (3281 to 6562 ft)
<b>Relative humidity</b>	Lower than 95% (without condensation)
<b>Degree of protection</b>	IP20/optional NEMA 1 enclosure
<b>Enclosure colour</b>	NCS 1502-Y, RAL 9002, PMS 420 C
<b>Contamination levels</b>	IEC721-3-3 No conductive dust allowed Class 1C2 (chemical gases) Class 1S2 (solid particles) Class 2C2 (chemical gases) Class 2S2 (solid particles) Class 3C2 (chemical gases) Class 3S2 (solid particles)
<b>Transportation</b>	
<b>Storage</b>	
<b>Operation</b>	
<b>Product compliance</b>	
Low Voltage Directive 2006/95/EC Machinery Directive 2006/42/EC EMC Directive 2004/108/EC Quality assurance system ISO 9001 Environmental system ISO 14001 UL, cUL, CE, C-Tick and GOST R approvals RoHS compliant	

<b>Programmable control connections</b>	
<b>Two analog inputs</b>	
Voltage signal	
Unipolar	0 (2) to 10 V, $R_{in} > 312 \text{ k}\Omega$
Bipolar	-10 to 10 V, $R_{in} > 312 \text{ k}\Omega$
Current signal	
Unipolar	0 (4) to 20 mA, $R_{in} = 100 \Omega$
Bipolar	-20 to 20 mA, $R_{in} = 100 \Omega$
Potentiometer reference value	10 V $\pm$ 1% max. 10 mA, $R < 10 \text{ k}\Omega$
Resolution	0.1%
Accuracy	$\pm$ 2%
<b>One analog output</b>	0 (4) to 20 mA, load $< 500 \Omega$
<b>Auxiliary voltage</b>	24 V DC $\pm$ 10%, max. 200 mA
<b>Five digital inputs</b>	
	12 to 24 V, PNP and NPN, programmable DI5 0 to 16 kHz pulse train
Input impedance	2.4 k $\Omega$
<b>One relay output</b>	
Type	NO + NC
Maximum switching voltage	250 V AC/30 V DC
Maximum switching current	0.5 A/30 V DC; 5 A/230 V AC
Maximum continuous current	2 A rms
<b>One digital output</b>	
Type	Transistor output
Maximum switching voltage	30 V DC
Maximum switching current	100 mA/30 V DC, short circuit protected
Frequency	10 Hz to 16 kHz
Resolution	1 Hz
Accuracy	0.2%
<b>Serial communication</b>	
<b>Fieldbuses</b>	
Cable	Modbus EIA-485, embedded Shielded twisted pair, impedance 100 to 150 ohms
Termination	Daisy-chained bus, without dropout lines
Isolation	Bus interface isolated from drive
Transfer rate	1.2 to 76.8 kbit/s
Communication type	Serial, asynchronous, half duplex
Protocol	Modbus
<b>Chokes</b>	
<b>AC input chokes</b>	External option. For reducing THD in partial loads and to comply with EN/IEC 61000-3-12.
<b>AC output chokes</b>	External option. To achieve longer motor cables

# Dimensions and weights

## Cabinet-mounted drives (IP20/UL open)

Frame size	IP20/UL Open					
	H1 (mm)	H2 (mm)	H3 (mm)	W (mm)	D (mm)	Weight (kg)
R0	169	202	239	70	161	1.2
R1	169	202	239	70	161	1.2
R2	169	202	239	105	165	1.5
R3	169	202	236	169	169	2.5
R4	181	202	244	260	169	4.4

H1 = Height without fastenings and clamping plate

H2 = Height with fastenings but without clamping plate

H3 = Height with fastenings and clamping plate

W = Width

D = Depth

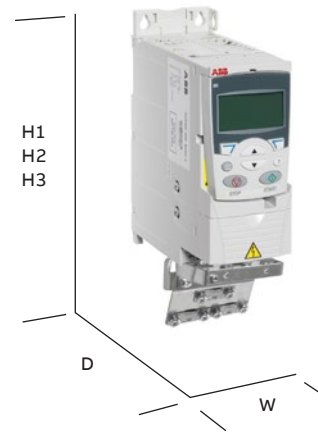

## Wall-mounted drives (NEMA 1)

Frame size	NEMA 1/UL Type 1					
	H4 (mm)	H5 (mm)	W (mm)	D1 (mm)	D2 (mm)	Weight (kg)
R0	257	280	70	169	187	1.6
R1	257	280	70	169	187	1.6
R2	257	282	105	169	191	1.9
R3	260	299	169	177	195	3.1
R4	270	320	260	177	195	5.0

H4 = Height with fastenings and NEMA 1 connection box

H5 = Height with fastenings, NEMA 1 connection box and hood

W = Width

D = Depth

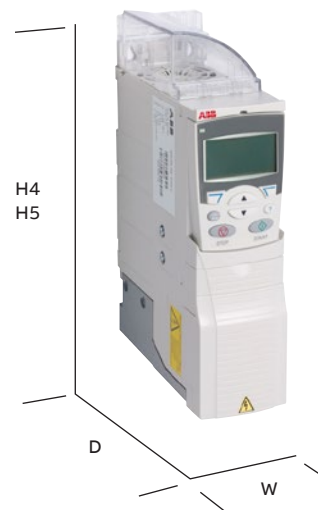



# Cooling and fuses

## Cooling

ACS310 is fitted with cooling fans as standard. The cooling air must be free from corrosive substances and must not be above the maximum ambient temperature of 50 °C. For more specific limits see the Technical data – Environmental limits in this catalog.

Cooling air flow					
Type designation	Frame size	Heat dissipation		Air flow	
		(W)	BTU/hr <sup>1)</sup>	m <sup>3</sup> /h	ft <sup>3</sup> /min
<b>1-phase AC supply, 200 to 240 V</b>					
ACS310-01X-02A4-2	R0	48	163	– <sup>2)</sup>	– <sup>2)</sup>
ACS310-01X-04A7-2	R1	72	247	24	14
ACS310-01X-06A7-2	R1	97	333	24	14
ACS310-01X-07A5-2	R2	101	343	21	12
ACS310-01X-09A8-2	R2	124	422	21	12
<b>3-phase AC supply, 200 to 240 V</b>					
ACS310-03X-02A6-2	R0	42	142	– <sup>2)</sup>	– <sup>2)</sup>
ACS310-03X-03A9-2	R0	54	183	– <sup>2)</sup>	– <sup>2)</sup>
ACS310-03X-05A2-2	R1	64	220	24	14
ACS310-03X-07A4-2	R1	86	295	24	14
ACS310-03X-08A3-2	R1	88	302	21	12
ACS310-03X-10A8-2	R2	111	377	21	12
ACS310-03X-14A6-2	R2	140	476	52	31
ACS310-03X-19A4-2	R2	180	613	52	31
ACS310-03X-26A8-2	R3	285	975	71	42
ACS310-03X-34A1-2	R4	328	1119	96	57
ACS310-03X-50A8-2	R4	488	1666	96	57
<b>3-phase AC supply, 380 to 480 V</b>					
ACS310-03X-01A3-4	R0	35	121	– <sup>2)</sup>	– <sup>2)</sup>
ACS310-03X-02A1-4	R0	40	138	– <sup>2)</sup>	– <sup>2)</sup>
ACS310-03X-02A6-4	R1	50	170	13	8
ACS310-03X-03A6-4	R1	60	204	13	8
ACS310-03X-04A5-4	R1	69	235	13	8
ACS310-03X-06A2-4	R1	90	306	19	11
ACS310-03X-08A0-4	R1	107	364	24	14
ACS310-03X-09A7-4	R1	127	433	24	14
ACS310-03X-13A8-4	R3	161	551	52	31
ACS310-03X-17A2-4	R3	204	697	52	31
ACS310-03X-25A4-4	R3	301	1029	71	42
ACS310-03X-34A1-4	R4	408	1393	96	57
ACS310-03X-41A8-4	R4	498	1700	96	57
ACS310-03X-48A4-4	R4	588	2007	96	57

X within the type designation stands for E or U.

<sup>1)</sup> BTU/hr = British Thermal Unit per hour. BTU/hr is approximately 0.293 Watts.

<sup>2)</sup> Frame size R0 with free convection cooling.

## Free space requirements

Enclosure type	Space above (mm)	Space below (mm)	Space on left/right (mm)
All frame sizes	75	75	0

## Fuses

Standard fuses can be used with ACS310 drives for branch circuit protection. Use the following table for selecting the correct input fuse for each drive.

Selection table					
Type designation	Frame size	IEC fuses		UL fuses	
		Max. (A)	Fuse type <sup>*)</sup>	Max. (A)	Fuse type <sup>*)</sup>
<b>1-phase AC supply, 200 to 240 V</b>					
ACS310-01X-02A4-2	R0	10	gG	10	UL class T
ACS310-01X-04A7-2	R1	16	gG	20	UL class T
ACS310-01X-06A7-2	R1	16	gG	25	UL class T
ACS310-01X-07A5-2	R2	20	gG	30	UL class T
ACS310-01X-09A8-2	R2	25	gG	35	UL class T
<b>3-phase AC supply, 200 to 240 V</b>					
ACS310-03X-02A6-2	R0	10	gG	10	UL class T
ACS310-03X-03A9-2	R0	10	gG	10	UL class T
ACS310-03X-05A2-2	R1	10	gG	15	UL class T
ACS310-03X-07A4-2	R1	16	gG	15	UL class T
ACS310-03X-08A3-2	R1	16	gG	15	UL class T
ACS310-03X-10A8-2	R2	16	gG	20	UL class T
ACS310-03X-14A6-2	R2	25	gG	30	UL class T
ACS310-03X-19A4-2	R2	25	gG	35	UL class T
ACS310-03X-26A8-2	R3	63	gG	60	UL class T
ACS310-03X-34A1-2	R4	80	gG	80	UL class T
ACS310-03X-50A8-2	R4	100	gG	100	UL class T
<b>3-phase AC supply, 380 to 480 V</b>					
ACS310-03X-01A3-4	R0	10	gG	10	UL class T
ACS310-03X-02A1-4	R0	10	gG	10	UL class T
ACS310-03X-02A6-4	R1	10	gG	10	UL class T
ACS310-03X-03A6-4	R1	10	gG	10	UL class T
ACS310-03X-04A5-4	R1	16	gG	15	UL class T
ACS310-03X-06A2-4	R1	16	gG	15	UL class T
ACS310-03X-08A0-4	R1	16	gG	20	UL class T
ACS310-03X-09A7-4	R1	20	gG	25	UL class T
ACS310-03X-13A8-4	R3	25	gG	30	UL class T
ACS310-03X-17A2-4	R3	35	gG	35	UL class T
ACS310-03X-25A4-4	R3	50	gG	50	UL class T
ACS310-03X-34A1-4	R4	80	gG	80	UL class T
ACS310-03X-41A8-4	R4	100	gG	100	UL class T
ACS310-03X-48A4-4	R4	100	gG	100	UL class T

The rated fuse currents given in the table are the maximums for the mentioned fuse types.

X within the type designation stands for E or U.

<sup>\*)</sup> According to IEC-60269 standard.

For U.S. market please see ACS310 U.S. catalog.

# Control connections

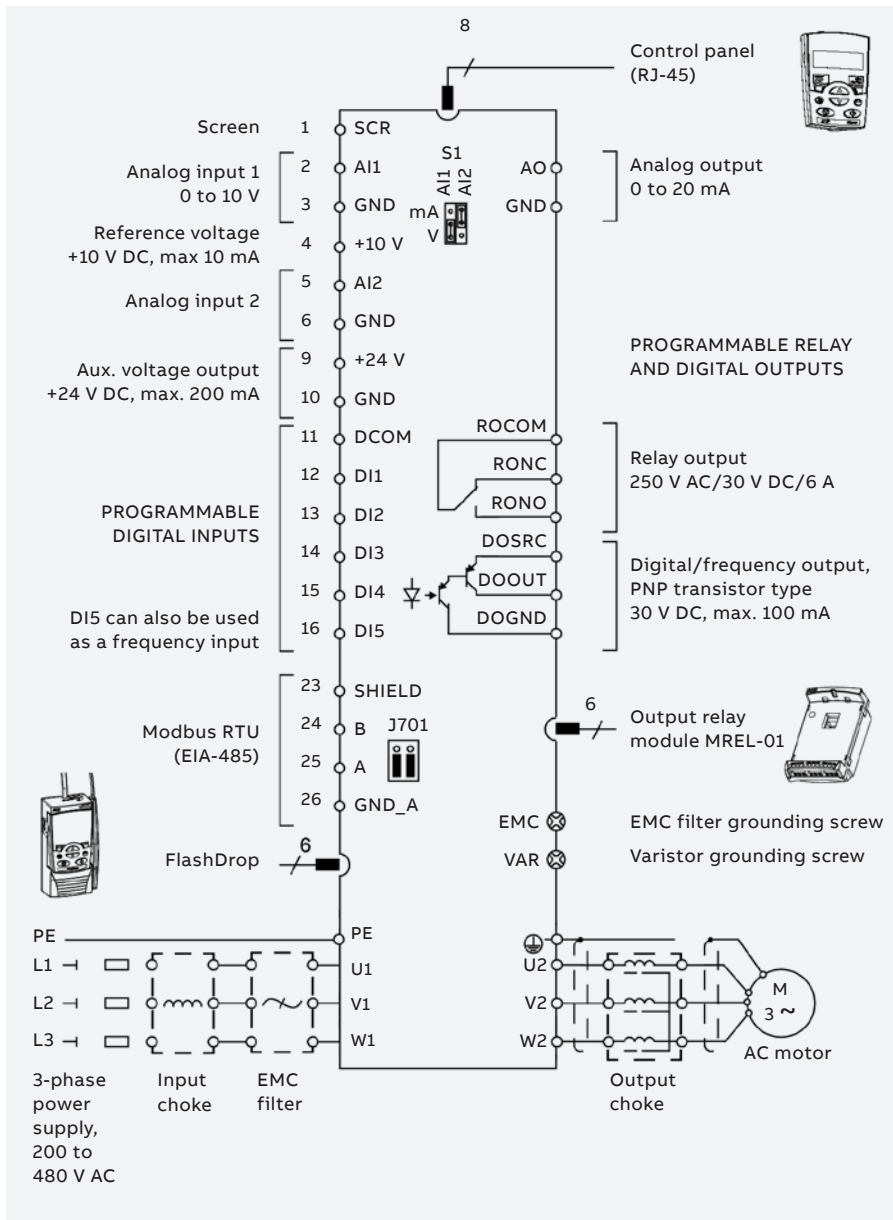

## Application macros

Application macros are preprogrammed parameter sets. While starting up the drive, the user typically selects one of the macros that is best suited for the application. The diagram gives an overview of ACS310 control connections and shows the default I/O connections for the ABB standard macro.

- ABB standard macro
- 3-wire macro
- Alternative macro
- Motor potentiometer
- Hand/auto macro
- PID control macro
- PFC control macro
- SPFC control macro
- Modbus application macro

In addition to the standard macros, the user can create three user macros. The user macro allows the user to save the parameter settings for later use.

The diagram below gives an overview of ACS310 control connections. Please refer to the ACS310 user's manual for more detailed information.

## Typical I/O connections

DI configuration NPN connected (sink)

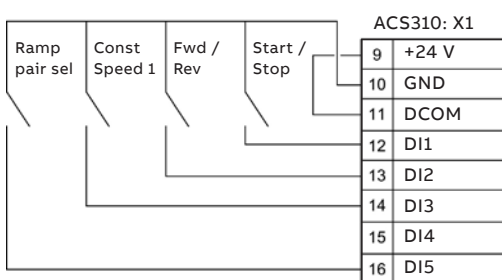

DI configuration PNP connected (source) with external power supply

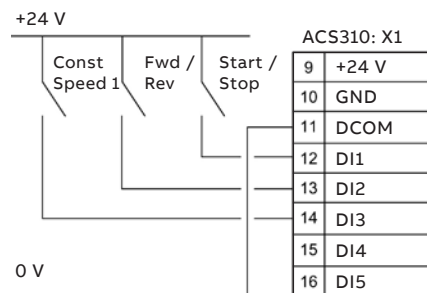

# Control program example

One of the ACS310's integrated pump and fan features is soft pump and fan control (SPFC), which is used for pump and fan alternation applications where lower pressure peaks are desirable when a new auxiliary motor is connected on-line. The following example explains how ACS310 can operate up to 4 to 5 pumps or fans in parallel based on the capacity demand. In this example, we use three parallel pumps to maintain the water pressure in the pipelines.

The drive controls the motor of pump 1, varying the motor speed to control the pump capacity. This motor is the speed regulated motor. When the demand exceeds that of the first motor's, the drive automatically starts an auxiliary pump. The speed of the first pump is adjusted so that the actual value follows the process reference.

## Parameter settings

Before starting the configuration, ensure that the drive has been installed properly and that the electrical connections are complete. Connection example can be found from ACS310 User's manual.

## Startup data

The correct motor parameters are set within parameter group 99. Then select SPFC control macro using parameter 9902. This software macro updates the defined list of parameter values to their default values.

## Pump and fan control parameters

Parameters can be found in parameter group 81. First change Short menu to to Long from parameter 1611 in group 16. This shows the full parameter group list including group 81.

## Frequency limits to start and stop auxiliary motors

Parameter 8109 START FREQ 1 is set to 50 Hz, which is also the default value. Since we have in this example also another auxiliary motor, parameter 8110 START FREQ 2 is set to 50 Hz for the second auxiliary motor. To stop an auxiliary motor we set parameters 8112 LOW FREQ 1 and 8113 LOW FREQ 2 to 25 Hz.

## Auxiliary motors start and stop delay

Delay stabilizes the contactors before starting or stopping a motor. Parameter 8115 AUX MOT START D is left to its default value 5 s. Parameter 8116 AUX MOT STOP D is left to its default value 20 s.





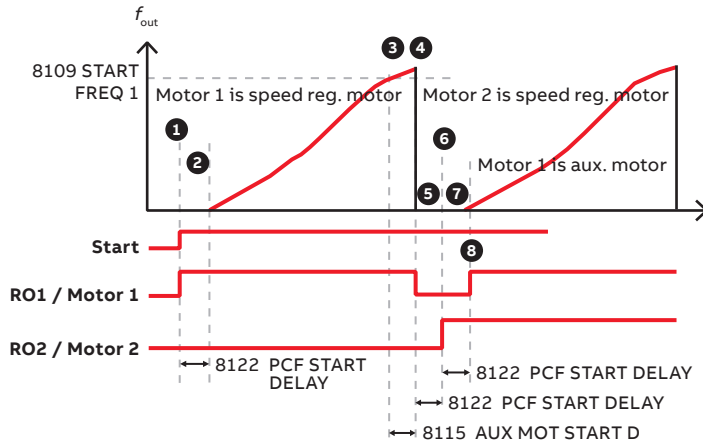

**Number of auxiliary motors and motors in total**

Parameter 8117 NR OF AUX MOT is set to 2.  
Parameter 8127 MOTORS is set to 3.

**Autochange functionality for SPFC**

The Autochange functionality for SPFC equalizes duty time between multiple motors, when auxiliary motors are not running. The time interval between motor changes is managed with parameter 8118.

**Interlocks**

Interlock detects if any of the pumps are unavailable and starts the next available pump, when used. Set parameter 8120 INTERLOCKS to take input from DI3 in this example (depends of the number of interlocks and how they are connected).

**Start delay for speed controlled motor**

Parameter 8122 PFC START DELAY is left to its default value 0.5 s.

**Enabling pump and fan control**

Parameter 8123 PFC ENABLE is set to 3 (SPFC + AUTOCHANGE)

**Relay configuration**

Relay configuration depends how many and how the motors are connected.

**Note!** The macro SPFC already sets Transistor output parameter 1805 DO SIGNAL to PFC as an additional relay output which is connected.

- Parameter 1401 RELAY OUTPUT 1 is set to PFC
- Parameter 1402 RELAY OUTPUT 2 is set to PFC

1. Hand: 0...10 V → 0...50 Hz.  
PID/PFC: 0...10 V → 0...100% PID setpoint.
2. 360 degree grounding under a clamp.
3. The signal source must be powered externally. See the manufacturer's instructions.

Default I/O settings		
<b>X1A</b>		
1	SCR	Signal cable shield (screen)
2	AI1	<b>Ext. ref. 1 (Hand) / Ext. ref. 2 (PID/PFC):</b> 0...10 V <sup>1)</sup>
3	GND	Analog input circuit common
4	+10 V	Reference voltage: +10 V DC, max. 10 mA
5	AI2	<b>Process actual value:</b> 4...20 mA <sup>3)</sup>
6	GND	Analog input circuit common
7	AO	<b>Output frequency value:</b> 0...20 mA
8	GND	Analog output circuit common
9	+24 V	Auxiliary voltage output: +24 V DC, max. 200 mA
10	GND	Auxiliary voltage output common
11	DCOM	Digital input common
12	DI1	<b>Stop (0) / Start (1) (Hand)</b>
13	DI2	<b>Hand (0) / PID/PFC (1) control selection</b>
14	DI3	<b>Interlock:</b> Deactivation always stops the drive
15	DI4	<b>Interlock:</b> Deactivation stops constant speed motor
16	DI5	<b>Stop (0) / Start (1) (PID/PFC)</b>
<b>X1B</b>		
17	ROCOM	Relay output 1 <b>PFC</b>
18	RONC	
19	RONO	
20	DOSRC	Digital output, max. 100 mA <b>PFC</b>
21	DOOUT	
22	DOGND	

# Options

## How to select options

The options shown in the table below are available within the ACS310 range.

The control panels have an associated 4-figure option code, which is shown in the second column.

It is this code that replaces XXXX in the type code above.

Options	Ordering code	Description	Model
Protection class	68566398 <sup>*)</sup>	NEMA 1/UL type 1 (R0, R1, R2)	MUL1-R1
	68566410 <sup>*)</sup>	NEMA 1/UL type 1 (R3)	MUL1-R3
	3AUA0000023888 <sup>*)</sup>	IP66/IP67/UL type 4X enclosure	
Control panel	J400	Assistant control panel	ACS-CP-A
	J404	Basic control panel	ACS-CP-C
Panel mounting kit	68294673 <sup>*)</sup>	Panel mounting kit	ACS/H-CP-EXT
	3AUA0000013086 <sup>*)</sup>	Panel holder mounting kit	OPMP-01
Extension modules	L511	Relay output extension module. Option includes three (3) additional relay outputs.	MREL-01
Tools	68566380 <sup>*)</sup>	FlashDrop tool	MFDT-01
	64532871 <sup>*)</sup>	DriveWindow Light	DriveWindow Light
External options	<sup>*)</sup>	Input chokes	
	<sup>*)</sup>	EMC filters	
	<sup>*)</sup>	Output chokes	
Remote monitoring	3AUA0000039179 <sup>*)</sup>	Ethernet adapter	SREA-01

<sup>\*)</sup> To be ordered as separate item.

<sup>1)</sup> The ACS310 is compatible with ACS-CP-C basic control panel Rev M or later.

<sup>2)</sup> The ACS310 is compatible with ACS-CP-A assistant control panel Rev E or later.  
New panel series manufactured since 2007 with serial number XYYWWRXXXX,  
where year Y = 7 or greater and revision R = E, F, G, ...)

# Options Interface

- 01 Panel cover (included as standard)
- 02 Basic control panel
- 03 Assistant control panel
- 04 Panel holder mounting kit OPMP-01
- 05 NEMA 1 kit
- 06 Terminal cover (included as standard)
- 07 Clamping plates (included as standard)



## User interface

### Panel cover

The purpose of the panel cover is to protect the drive's connection surfaces. The ACS310 drive is delivered with a panel cover as standard. In addition, there are two alternative control panels available as options.

### Basic control panel

The basic control panel features a single line numeric display. The panel can be used to control the drive, set parameter values or copy them from one drive to another.

### Assistant control panel

The assistant control panel features a multilingual alphanumeric display for easy drive programming. The control panel has various assistants and an built-in help function to guide the user. It includes a real time clock, which can be used during fault logging and in controlling the drive, such as at start/stop. The control panel can be used for copying parameters for back up or for downloading to another drive. A large graphical display and soft keys make it extremely easy to navigate.

### Panel mounting kits

To attach the control panel to the outside of a larger enclosure, two panel mounting kits are available. A simple and cost-efficient installation is possible with the ACS/H-CP-EXT kit, while the OPMP-01 kit provides a more user-friendly solution, including a panel platform that enables the panel to be removed in the same way as a drive-mounted panel. The panel mounting kits include all hardware required eg, 3 m extension cables and installation instructions.

## Protection and installation

### NEMA 1 kit

The NEMA 1 kit includes a connection box for finger protection, conduit tube installation, and a hood for protection against dirt and dust.

### Terminal cover

The terminal cover is for protection of the I/O connections.

### Clamping plates

The clamping plates are used for protection against electrical disturbances. The clamping plates with the clamps are included in the drive package as standard.

# Options

## User interfaces

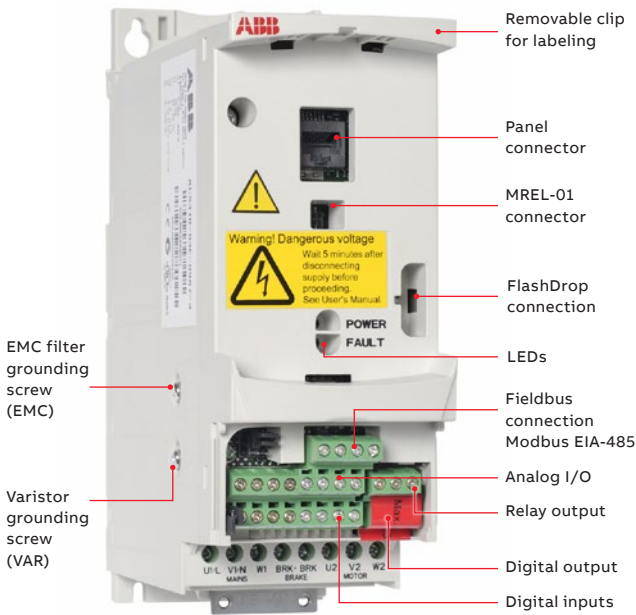

01 Extension module MREL-01

02 SREA-01 Ethernet adapter



### Serial communication

The embedded Modbus EIA-485 fieldbus brings connectivity to major automation systems. A single twisted pair cable avoids large amounts of conventional cabling, thereby reducing costs and increasing system reliability.

#### Modbus TCP to Modbus RTU gateway

Additionally SREA-01 Ethernet adapter offers Modbus TCP to Modbus RTU gateway functionality which enables Modbus TCP connectivity to ACS310. Please refer to SREA-01 user's guide for more detailed information.

### Extension module

#### MREL-01

ACS310 has one relay output as standard. The optional MREL-01 module offers three additional relay outputs. The outputs can be configured for different functions by setting selected parameters.

#### SREA-01 Ethernet adapter

SREA-01 Ethernet adapter with remote monitoring access can send process data, data logs and event messages independently, without a PLC or a dedicated on-site computer. It has an internal web server for configuration and drive access.

In remote locations without qualified service people on-site it is vital to be able to monitor the drive remotely. Monitoring and diagnostics routines can be easily implemented with ABB's remote monitoring tool. The remote monitoring tool enables the connection of multiple drives to Ethernet, to collect operational data from the process and send the collected data to a central location for process monitoring and further analysis.

# Options

## Software tools

A separate order line and type code is required for any of these software tool options.

### DriveWindow Light

DriveWindow Light is an easy-to-use startup and maintenance tool for ACS310 drives. It can be used in an offline mode, which enables parameter setting at the office even before going to the actual site. The parameter browser enables viewing, editing and saving of parameters. The parameter comparison feature makes it possible to compare parameter values between the drive and saved parameter files. With the parameter subset you can create your own parameter sets. Controlling the drive is one of the features in DriveWindow Light. With this software tool, you can monitor up to four signals simultaneously. This can be done in both graphical and numerical format. DriveWindow Light version 2.9 or later is compatible with ACS310 drives.

### Startup wizards

Startup wizards make the setting of parameters easy. Simply launch the wizard, select an appropriate assistant eg, for setting analog outputs, and all parameters related to this function are shown together with help pictures.

### Highlights

- Editing, saving and downloading parameters
- Graphical and numerical signal monitoring
- Drive control
- Startup wizards



# Options

## External

A separate order line and type designation is required for any of these external options.

—  
01 FlashDrop tool

### FlashDrop tool

FlashDrop is a powerful palm sized tool for fast and easy parameter selecting and setting. It gives the possibility to hide selected parameters to protect the machine. Only the parameters needed in the application are shown. The tool can copy parameters between two drives or between a PC and a drive. All the above can be done without a power connection to the drive – in fact, it is not even necessary to unpack the drive.



### DrivePM

DrivePM (Drive parameter manager) is a tool to create, edit and copy parameter sets for FlashDrop. For each parameter/group the user has a possibility to hide it, which means that the drive user does not see the parameter/group at all. DrivePM version 1.2 is compatible with ACS310 drives.

### FlashDrop package includes

- FlashDrop tool
- DrivePM software
- User's manual in English
- Cable OPCA-02 for connection between the PC and FlashDrop tool
- Battery charger

Type designation ACS310-	Frame size	Input choke	$I_{IN}$ without choke (A)	$I_{IN}$ with choke <sup>1)</sup> (A)	$I_{TH}$ (A)	$L$ (mH)
<b>1-phase AC supply, 200 to 240 V</b>						
01X-02A4-2	R0	CHK-A1	6.1	4.5	5	8.0
01X-04A7-2	R1	CHK-B1	11.4	8.1	10	2.8
01X-06A7-2	R1	CHK-C1	16.1	11	16	1.2
01X-07A5-2	R2	CHK-C1	16.8	12	16	1.2
01X-09A8-2	R2	CHK-D1	21	15	25	1.0
<b>3-phase AC supply, 200 to 240 V</b>						
03X-02A6-2	R0	CHK-01	4.7	2.6	4.2	6.4
03X-03A9-2	R0	CHK-02	6.7	3.5	7.6	4.6
03X-05A2-2	R1	CHK-03	8.4	4.2	13	2.7
03X-07A4-2	R1	CHK-03	13	6.1	13	2.7
03X-08A3-2	R1	CHK-04	13.2	6.9	22	1.5
03X-10A8-2	R2	CHK-04	15.7	9.2	22	1.5
03X-14A6-2	R2	CHK-04	23.9	13	22	1.5
03X-19A4-2	R2	CHK-04	27.3	13.3	22	1.5
03X-26A8-2	R3	CHK-06	45	20.9	47	0.7
03X-34A1-2	R4	CHK-06	55	26.2	47	0.7
03X-50A8-2	R4	CHK-06	76	41	47	0.7
<b>3-phase AC supply, 380 to 480 V</b>						
03X-01A3-4	R0	CHK-01	2.4	1.3	4.2	6.4
03X-02A1-4	R0	CHK-01	4.9	2	4.2	6.4
03X-02A6-4	R1	CHK-01	4.5	2.5	4.2	6.4
03X-03A6-4	R1	CHK-01	6.6	3.5	4.2	6.4
03X-04A5-4	R1	CHK-02	7.6	3.8	7.6	4.6
03X-06A2-4	R1	CHK-02	10.6	5.3	7.6	4.6
03X-08A0-4	R1	CHK-02	12.8	6.8	7.6	4.6
03X-09A7-4	R1	CHK-03	15	8.6	13	2.7
03X-13A8-4	R3	CHK-03	20.7	12.3	13	2.7
03X-17A2-4	R3	CHK-04	24.3	12.6	22	1.5
03X-25A4-4	R3	CHK-04	34	19.5	22	1.5
03X-34A1-4	R4	CHK-05	57	27.2	33	1.1
03X-41A8-4	R4	CHK-06	67	35.2	47	0.7
03X-48A4-4	R4	CHK-06	74	42	47	0.7

<sup>1)</sup> Values at 50 Hz/230 V and at 50 Hz/400 V power supplies

$I_{IN}$  = Nominal input current  
 $I_{TH}$  = Nominal choke thermal current  
 $L$  = Choke inductance

**Input chokes**

An input choke smoothens the wave shape of mains current and reduces total harmonic distortion (THD). Together with the input choke, the ACS310 is designed to fulfill the requirements of the harmonics standard EN/IEC 61000-3-12. In addition, the input choke provides improved protection against mains voltage transients.

Type designation ACS310-	Frame size	Output choke	Cable length (m)
<b>1-phase AC supply, 200 to 240 V</b>			
01X-02A4-2	R0	ACS-CHK-B3	60
01X-04A7-2	R1	ACS-CHK-B3	100
01X-06A7-2	R1	ACS-CHK-C3	100
01X-07A5-2	R2	ACS-CHK-C3	100
01X-09A8-2	R2	ACS-CHK-C3	100
<b>3-phase AC supply, 200 to 240 V</b>			
03X-02A6-2	R0	ACS-CHK-B3	60
03X-03A9-2	R0	ACS-CHK-B3	60
03X-05A2-2	R1	ACS-CHK-B3	100
03X-07A4-2	R1	ACS-CHK-C3	100
03X-08A3-2	R1	ACS-CHK-C3	100
03X-10A8-2	R2	ACS-CHK-C3	100
03X-14A6-2	R2	NOCH-0016-6x	100
03X-19A4-2	R2	NOCH-0016-6x	100
03X-26A8-2	R3	NOCH-0030-6x	100
03X-34A1-2	R4	NOCH-0030-6x	100
03X-50A8-2	R4	NOCH-0070-6x	100
<b>3-phase AC supply, 380 to 480 V</b>			
03X-01A3-4	R0	ACS-CHK-B3	60
03X-02A1-4	R0	ACS-CHK-B3	60
03X-02A6-4	R1	ACS-CHK-B3	100
03X-03A6-4	R1	ACS-CHK-B3	100
03X-04A5-4	R1	ACS-CHK-C3	100
03X-06A2-4	R1	ACS-CHK-C3	100
03X-08A0-4	R1	NOCH-0016-6x	100
03X-09A7-4	R1	NOCH-0016-6x	100
03X-13A8-4	R3	NOCH-0016-6x	100
03X-17A2-4	R3	NOCH-0016-6x	100
03X-25A4-4	R3	NOCH-0030-6x	100
03X-34A1-4	R4	NOCH-0030-6x	100
03X-41A8-4	R4	NOCH-0030-6x	100
03X-48A4-4	R4	NOCH-0070-6x	100

**Output chokes**

An output choke decreases du/dt on the output and filters current spikes caused by voltage spikes. With an output choke it is possible to increase the motor cable length which could be otherwise limited due to a temperature increase resulting from current spikes and electromagnetic performance.

# Options

## External

A separate order line and type designation is required for any of these external options.

### EMC filters

The ACS310's internal EMC filter is designed to meet category C3 requirements of EN/IEC 61800-3 standard. External EMC filters are used to enhance the drives electromagnetic performance in conjunction with its internal filtering. Maximum motor cable length depends on required electromagnetic performance, according to the table below.

Type designation ACS310-	Frame size	Filter type	Cable length <sup>1)</sup> with external EMC filter			Cable length <sup>1)</sup> without external EMC filter	
			C1 (m)	C2 (m)	C3 (m)	C3 (m)	C4 (m)
<b>1-phase AC supply, 200 to 240 V</b>							
01X-02A4-2	R0	RFI-11	10	30	–	30	30
01X-04A7-2	R1	RFI-12	10	30	50	30	50
01X-06A7-2	R1	RFI-12	10	30	50	30	50
01X-07A5-2	R2	RFI-13	10	30	50	30	50
01X-09A8-2	R2	RFI-13	10	30	50	30	50
<b>3-phase AC supply, 200 to 240 V</b>							
03X-02A6-2	R0	RFI-32	10	30	–	30	30
03X-03A9-2	R0	RFI-32	10	30	–	30	30
03X-05A2-2	R1	RFI-32	10	30	50	30	50
03X-07A4-2	R1	RFI-32	10	30	50	30	50
03X-08A3-2	R1	RFI-32	10	30	50	30	50
03X-10A8-2	R2	RFI-32	10	30	50	30	50
03X-14A6-2	R2	RFI-33	10	30	50	30	50
03X-19A4-2	R2	RFI-33	10	30	50	30	50
03X-26A8-2	R3	RFI-34	10	30	50	30	50
03X-34A1-2	R4	RFI-34	10	30	50	30	50
03X-50A8-2	R4	RFI-34	10	30	50	30	50
<b>3-phase AC supply, 380 to 480 V</b>							
03X-01A3-4	R0	RFI-32	30	30	–	30	30
03X-02A1-4	R0	RFI-32	30	30	–	30	30
03X-02A6-4	R1	RFI-32	50	50	50	30	50
03X-03A6-4	R1	RFI-32	50	50	50	30	50
03X-04A5-4	R1	RFI-32	50	50	50	30	50
03X-06A2-4	R1	RFI-32	50	50	50	30	50
03X-08A0-4	R1	RFI-32	50	50	50	30	50
03X-09A7-4	R1	RFI-32	50	50	50	30	50
03X-13A8-4	R3	RFI-33	40	40	40	30	50
03X-17A2-4	R3	RFI-33	40	40	40	30	50
03X-25A4-4	R3	RFI-33	40	40	40	30	50
03X-34A1-4	R4	RFI-34	–	30	–	30	50
03X-41A8-4	R4	RFI-34	–	30	–	30	50
03X-48A4-4	R4	RFI-34	–	30	–	30	50

<sup>1)</sup> Internal EMC filter must be connected with the EMC screw in the drive. When the filter is not connected the C4 maximum cable lengths are allowed to be used.

### Low leakage current filters

Low leakage current filters are ideal for installations where residual current devices (RCD) are required and leakage current needs to be below 30 mA.

Type designation ACS355-	Frame size	Filter type	Cable length <sup>1)</sup> with LRFI filter
			C2 (m)
<b>Low leakage current filters, 3-phase AC supply, 400 V</b>			
03X-01A3-4	R0	LRFI-31	10
03X-02A1-4	R0	LRFI-31	10
03X-02A6-4	R1	LRFI-31	10
03X-03A6-4	R1	LRFI-31	10
03X-04A5-4	R1	LRFI-31	10
03X-06A2-4	R1	LRFI-31	10
03X-08A0-4	R1	LRFI-32	10
03X-09A7-4	R1	LRFI-32	10

<sup>1)</sup> Internal EMC filter must be disconnected by removing the EMC screw from the drive.

### EMC standards in general

EN 61800-3 (2004), product standard	EN 55011, product family standard for industrial, scientific and medical (ISM) equipment	EN 61800-3/A11 (2000), product standard
Category C1	Group 1 Class B	1 <sup>st</sup> environment, unrestricted distribution
Category C2	Group 1 Class A	1 <sup>st</sup> environment, restricted distribution
Category C3	Group 2 Class A	2 <sup>nd</sup> environment, unrestricted distribution
Category C4	Not applicable	2 <sup>nd</sup> environment, restricted distribution



# Compact AC500-eCo PLC with ACS310

ABB's programmable logic controller AC500-eCo can be used for controlling and monitoring the system, for applications that require complex control logic and when several drives are connected together through Modbus link.

### Easy commissioning and fast startup

Additionally SREA-01 Ethernet adapter offers Modbus TCP to Modbus RTU gateway functionality which enables Modbus TCP connectivity to ACS310. Please refer to SREA-01 user's guide for more detailed information.

### Compact design saves installation space

- The compact size of the PLC and drive provides flexibility when integrating into existing or new system designs.
- AC500-eCo is an economical, entry level PLC for stand-alone solutions and equipment control. It saves space due to onboard digital and analog I/O. AC500-eCo is easy to program and provides six programming languages.

### Flexible system expansion

When the system requirements expand, ABB's wide product range provides a flexible and cost-efficient way to meet the system's growing needs.

AC500-eCo belongs to the AC500 PLC platform. AC500 is a scalable and modular platform which can be combined and flexibly expanded to suit either decentralized or centralized configurations.

Automation Builder, the programming tool for AC500, is based on IEC 61131-3 standard. Automation Builder is used for the entire AC500 PLC platform. Automation Builder easily allows to change the CPU in an existing configuration to fit the CPU type to the performance need of the application.

Ready-made communication and control blocks for AC500-eCo and AC500 PLC range are available, supporting a wide range of ABB's low voltage AC drives.

### Benefits

- Control of a motor in minutes
- Cost-efficient system expansion, since the same application program can be used for the entire AC500 PLC platform
- Fast commissioning with ready-made Modbus macro



# ABB product offering

## ABB micro drives

ABB micro drives are designed to be incorporated into a wide variety of machines such as mixers, conveyors, fans or pumps or anywhere where a fixed speed motor needs connect with a variable speed motor. The ABB micro drives meet the requirements of OEMs, machinery builders and panel builders. These drives are widely available through the ABB distribution network. The drives are easy to select and provide a range of built-in features as standard. For more information, please visit [abb.com/drives](http://abb.com/drives).



## ABB general purpose drives

ABB general purpose drives are ideal in situations where there is a need for a drive that is easy to install, commission and use. They are designed to offer control over a broad range of standard drive applications and have a wide range of built-in features simplifying all operations. For more information, please visit [abb.com/drives](http://abb.com/drives).



## ABB's Programmable Logic Controllers PLCs

The AC500, AC500-eCo, AC500-S and AC500-XC scalable PLC ranges provide solutions for small, middle and high-end applications. Our AC500 PLC platform offers different performance levels and is the ideal choice for high availability, extreme environments or safety solutions. Our AC500 PLC platform offers interoperability and compatibility in hardware and software from compact PLCs up to high end and safety PLCs. For more information, please visit [abb.com/plc](http://abb.com/plc).

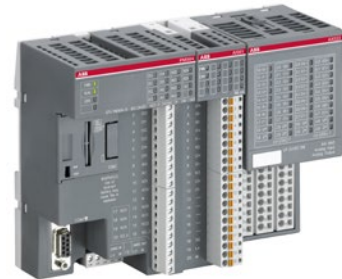



### Control panels

The CP600-eCo and CP600 HMI control panels offer a wide range of features and functionalities for maximum operability. ABB control panels are distinguished by their robustness and easy usability, providing all the relevant information from production plants and machines at a single touch. For more information, please visit [abb.com/plc](http://abb.com/plc).



### Automation Builder engineering suite

Automation Builder integrates engineering and maintenance for PLC, Drives, Motion, HMI and Robotics. Automation Builder is an integrated software suite for machine builders and system integrators wanting to automate their machines and systems in a productive way. Automation Builder combines the proven ABB tools RobotStudio, Drive manager, Drive Composer pro, Mint WorkBench, Panel Builder and succeeds Control Builder Plus. Build solutions with Drive application programming (IEC 61131-3), Drive management, configuration and diagnosis with common process data editor, and Drive engineering in Drive Composer pro. Download Automation Builder from [abb.com/automationbuilder](http://abb.com/automationbuilder).



### AC motors

ABB's low voltage AC motors are designed to save energy, reduce operating costs and enable demanding motor applications to perform reliably and without unscheduled downtime. General performance motors combine convenience and easy handling seamlessly with ABB's engineering expertise. Process performance motors provide the most comprehensive, versatile set of motors for the process industries and heavy-duty applications. For more information, please visit [abb.com/motors&generators](http://abb.com/motors&generators).

# Services to match your needs

Your service needs depend on your operation, life cycle of your equipment and business priorities. We have identified our customers' four most common needs and defined service options to satisfy them. What is your choice to keep your drives at peak performance?

Is uptime your priority?

Keep your drives running with precisely planned and executed maintenance.

**Example services include:**

- ABB Ability Life Cycle Assessment
- Installation and Commissioning
- Spare Parts
- Preventive Maintenance
- Reconditioning
- ABB Drive Care agreement
- Drive Exchange

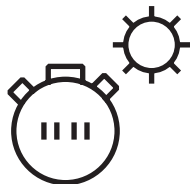

**Operational efficiency**

Is rapid response a key consideration?

If your drives require immediate action, our global network is at your service.

**Example services include:**

- Technical Support
- On-site Repair
- ABB Ability Remote Assistance
- Response time agreements
- Training

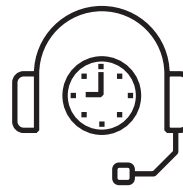

**Rapid response**

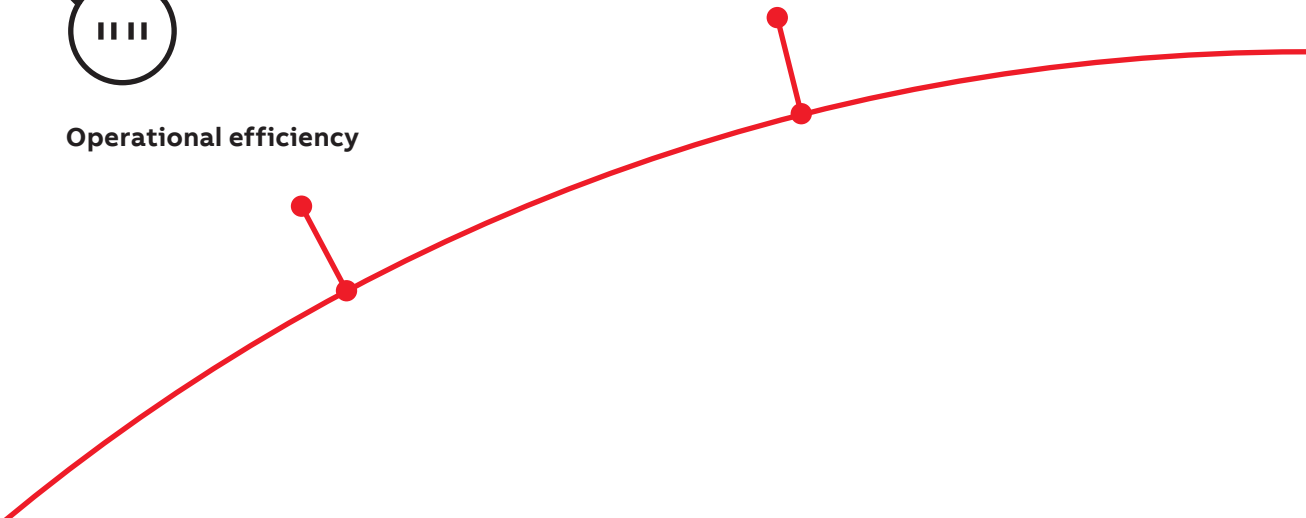

# Drives service

## Your choice, your future

### The future of your drives depends on the service you choose.

Whatever you choose, it should be a well-informed decision. No guesswork. We have the expertise and experience to help you find and implement the right service for your drive equipment. You can start by asking yourself these two critical questions:

- Why should my drive be serviced?
- What would my optimal service options be?

From here, you have our guidance and full support along the course you take, throughout the entire lifetime of your drives.

### Need to extend your assets' lifetime?

Maximize your drive's lifetime with our services.

#### Example services include:

- ABB Ability Life Cycle Assessment
- Upgrades, Retrofits and Modernization
- Replacement, Disposal and Recycling



Life cycle management

### Your choice, your business efficiency

ABB Drive Care agreement lets you focus on your core business. A selection of predefined service options matching your needs provides optimal, more reliable performance, extended drive lifetime and improved cost control. So you can reduce the risk of unplanned downtime and find it easier to budget for maintenance.

### Is performance most critical to your operation?

Get optimal performance out of your machinery and systems.

#### Example services include:

- ABB Ability Remote Services
- Engineering and Consulting
- Inspection and Diagnostics
- Upgrades, Retrofits and Modernization
- Workshop Repair
- Tailored services



Performance improvement

# A lifetime of peak performance

You're in control of every life cycle phase of your drives. At the heart of drive services is a four-phase product life cycle management model. This model defines the services recommended and available throughout drives lifespan.

Now it's easy for you to see the exact service and maintenance available for your drives.

**ABB drives life cycle phases explained:**

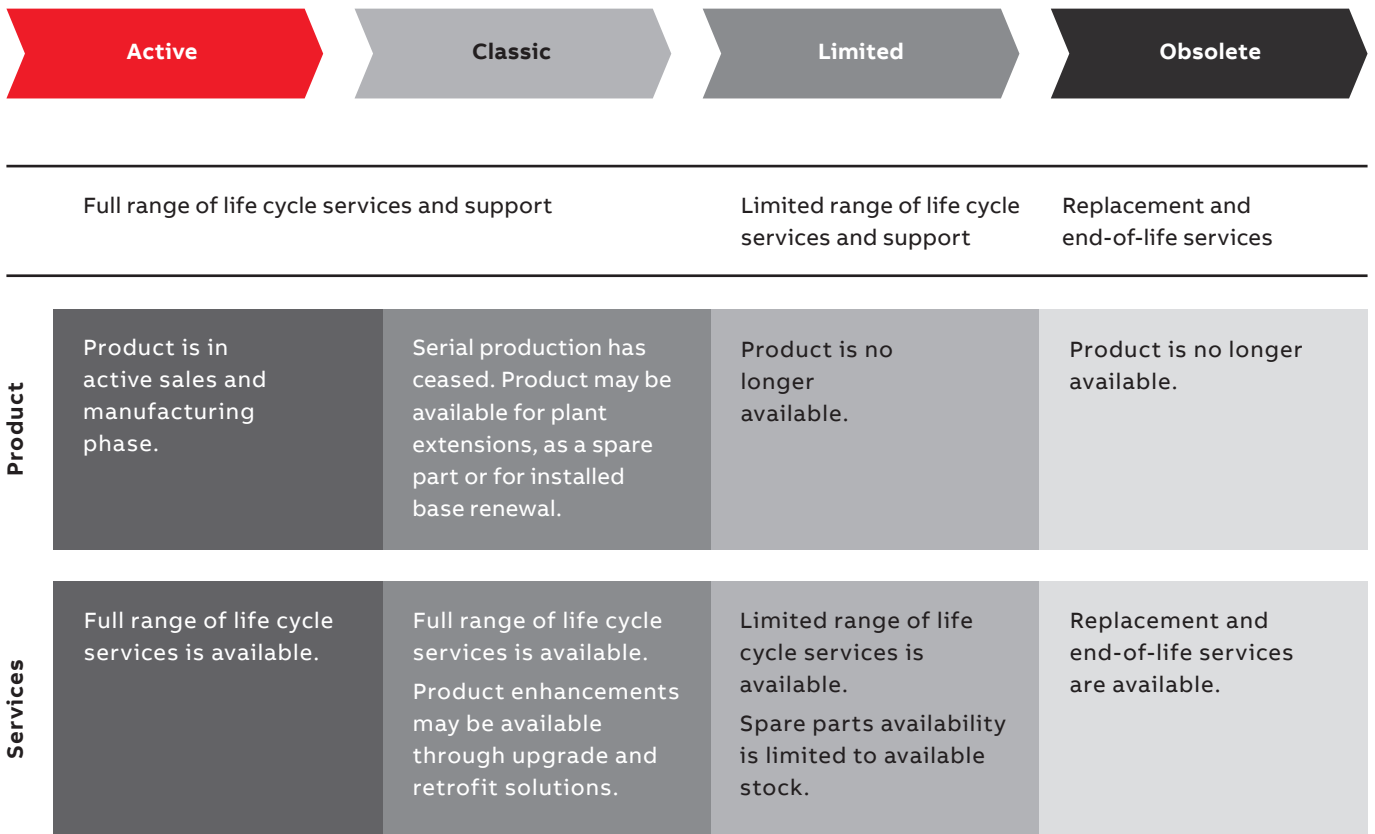

**Keeping you informed**  
 We notify you every step of the way using life cycle status statements and announcements.

Your benefit is clear information about your drives' status and precise services available. It helps you plan the preferred service actions ahead of time and make sure that continuous support is always available.

**Step 1**  
**Life Cycle Status Announcement**  
 Provides early information about the upcoming life cycle phase change and how it affects the availability of services.

**Step 2**  
**Life Cycle Status Statement**  
 Provides information about the drive's current life cycle status, availability of product and services, life cycle plan and recommended actions.



—  
For more information, please contact  
your local ABB representative or visit

**[abb.com/drives](http://abb.com/drives)**  
**[abb.com/drivespartners](http://abb.com/drivespartners)**  
**[abb.com/plc](http://abb.com/plc)**  
**[abb.com/automationbuilder](http://abb.com/automationbuilder)**

ACS310 how-to video:

